

# KAELO



## DESIGN & INSTALLATION GUIDE



# CONTENTS

1. Quick-step Guide .....	3
2. Intro to Kaelo .....	4
3. Inside the box .....	5
3.1 Base Unit box .....	5
3.2 Crown box .....	6
4. Design Allowance .....	7
4.1 Minimum Allowances .....	7
4.2 Hole Specification: Curved .....	8
4.3 Hole Specification: Flush .....	8
4.4 Hole Specification: Undermount .....	9
5. Ventilation .....	10
6. Install: Curved .....	13
7. Install: Flush .....	15
8. Install: Undermount .....	17
9. Power Up & Test .....	21
10. Specifications .....	23
11. Transport & Handling .....	24
12. Safety Notice .....	24

# 1. QUICK-STEP GUIDE

## CURVED & FLUSH DESIGNS ONLY

See page 9 & 17 for Undermount installations.

### STEP 1.

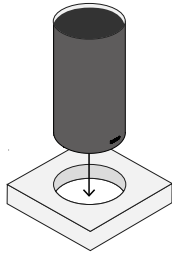

Lower *Kaelo* into fabricated hole.

\*Different hole size required for each style of *Kaelo*. Refer to page 8.

### STEP 2.

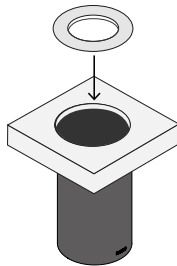

Place the Crown on *Kaelo*.

### STEP 3.

Connect *Kaelo* cord with the power supply cord.

### STEP 4.

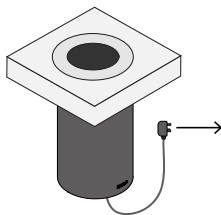

Plug power supply cord into mains power.

### STEP 5.

Turn on power socket.

# 2. INTRO TO KAELO

*Kaelo* keeps your drink at its opening temperature, so every sip is as good as the first.

It can be easily integrated into any surface. Simply specify a hole, slot *Kaelo* in, then plug into a mains socket. We recommend the hole is cut by a worktop fabricator, and installation can be completed by kitchen installers.

The Crown comes in three styles (Curved, Flush or Undermount), and each style of Crown has different installation requirements.



# 3. INSIDE THE BOX

## 3.1 BASE UNIT BOX:

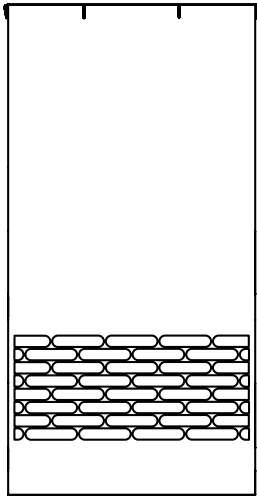

*Kaelo or  
Kaelo Plus*

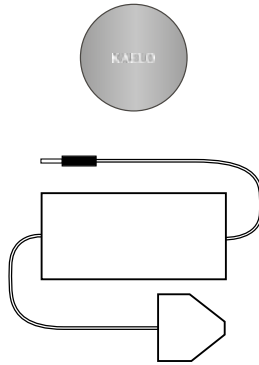

Rubber Mat  
Power Adapter

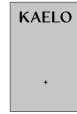

User Guide\*  
This Guide

*\*Ensure the User Guide is given to the end-user*

### 3.2 CROWN BOX: CURVED

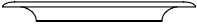

Curved Crown

### 3.3 CROWN BOX: FLUSH

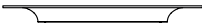

Flush Crown

### 3.4 CROWN BOX: UNDERMOUNT



Undermount Crown

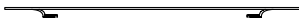

Locking Ring attached to Alignment Template



Screws



Alignment Template



Gasket

# 4. DESIGN ALLOWANCE

When designing with *Kaelo*, all that's required is the specification of a hole, an accessible power socket and, depending on the size of the void, a small vent to allow good airflow.

## 4.1 MINIMUM ALLOWANCES

Ensure that the void has a minimum internal height of 420mm and the *Kaelo* unit is at least 73mm away from the internal walls.

If installing multiple Curved or Flush *Kaelos* into one void, ensure that the centre points of each hole are least 200mm apart.

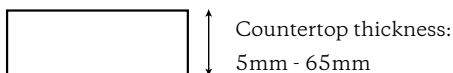
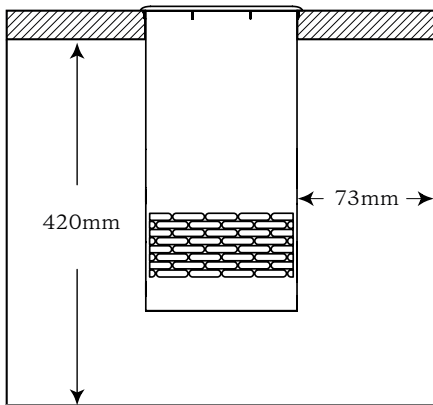

# IMPORTANT

Different hole size required for each style of *Kaelo*:

## 4.2 HOLE SPECIFICATION: CURVED

A 155mm hole can be created using CNC or water jet cutting.

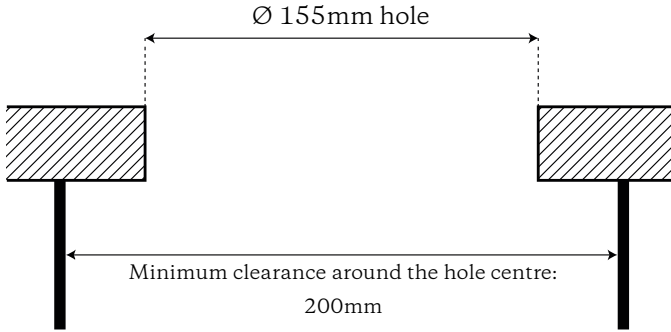

## 4.3 HOLE SPECIFICATION: FLUSH

Due to the required recess, the hole for a Flush *Kaelo* must be cut by fabricators only.

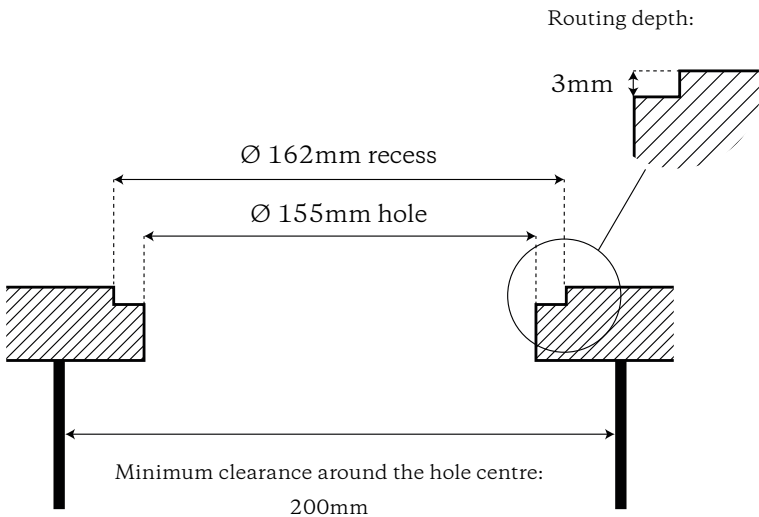



## 4.4 HOLE SPECIFICATION: UNDERMOUNT

A 125mm hole can be created using a CNC or water jet cutting.

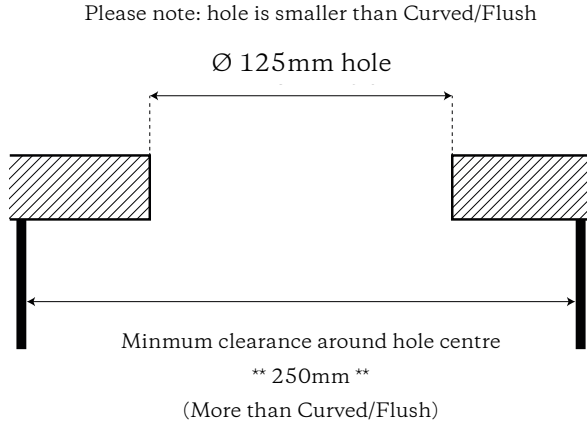

## 4.5 MARINE APPLICATIONS

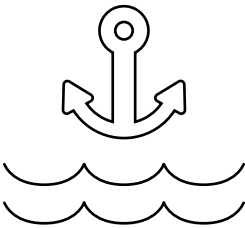

If designing *Kaelo* into a yacht or marine environment:

- Install in-cabin and keep dry
- Keep away from chlorinated water, such as hot tubs and swimming pools
- *Kaelo* is designed to withstand 15 volts DC for short periods of time, as is common when many vessels start up

# 5. VENTILATION

We advise that a small vent is included in all installations, to allow sufficient airflow to the *Kaelo* base unit. Be aware if the ambient air around the *Kaelo* is above 32 degrees, the unit will not function as intended and shutdown.

If ventilation isn't possible, there are larger voids which don't require it, see below for details. If ventilation isn't possible on a smaller void, we recommended not to install *Kaelo* in that location.

- A Ventilation is not required when *Kaelo* is installed into a void with a volume larger than 128,000,000mm<sup>3</sup>
- B A small vent is required when *Kaelo* is installed into a void with a volume smaller than 128,000,000mm<sup>3</sup>

*See following page for further instructions.*

## INSTALL CONSIDERATIONS

- Ensure *Kaelo* is not installed in close proximity to appliances that generate heat
- Ensure the base and sides of the *Kaelo* are not obstructed
- Ensure the base and sides of the *Kaelo* are not located in an area where they are vulnerable to damage or obstruction

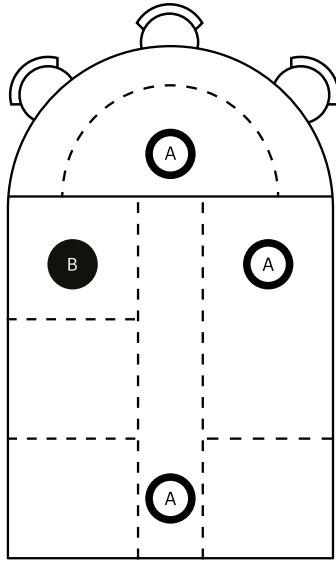

## 5.1 EXAMPLE A - NON-VENTED INSTALL

Voids that are greater than  $128,000,000\text{mm}^3$  do not require ventilation when a single *Kaelo* is installed.

If installing multiple *Kaelos* into a single void, ensure that the void allows for at least  $128,000,000\text{mm}^3$  per *Kaelo*, otherwise ventilation is required.

This example would not require ventilation:  
 $200\text{mm} \times 800\text{mm} \times 800\text{mm} = 128,000,000\text{mm}^3$

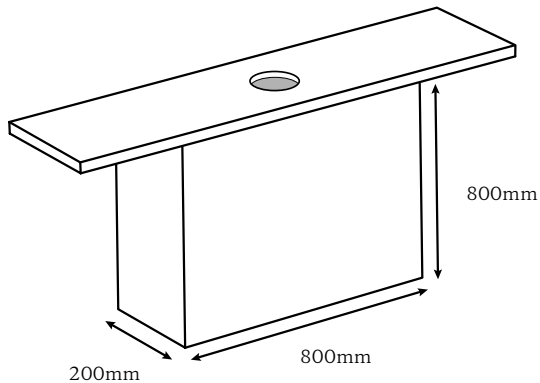

## 5.2 EXAMPLE B - VENTED INSTALL

Voids that are less than  $128,000,000\text{mm}^3$  require a small vent into another void or into ambient air to allow for better airflow circulation.

The vent should have an area of at least  $9,000\text{mm}^2$  and is usually best placed in the back panel.

This example would require a vent:  $300\text{mm} \times 300\text{mm} \times 800\text{mm} = 72,000,000\text{mm}^3$

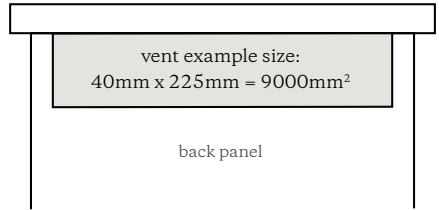
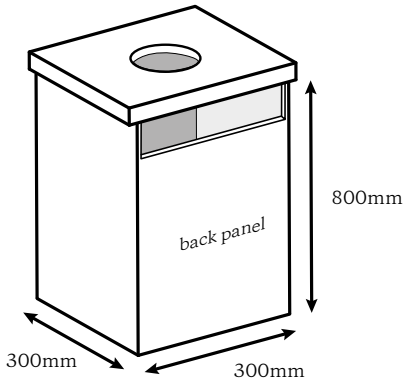

# 6. INSTALL: CURVED

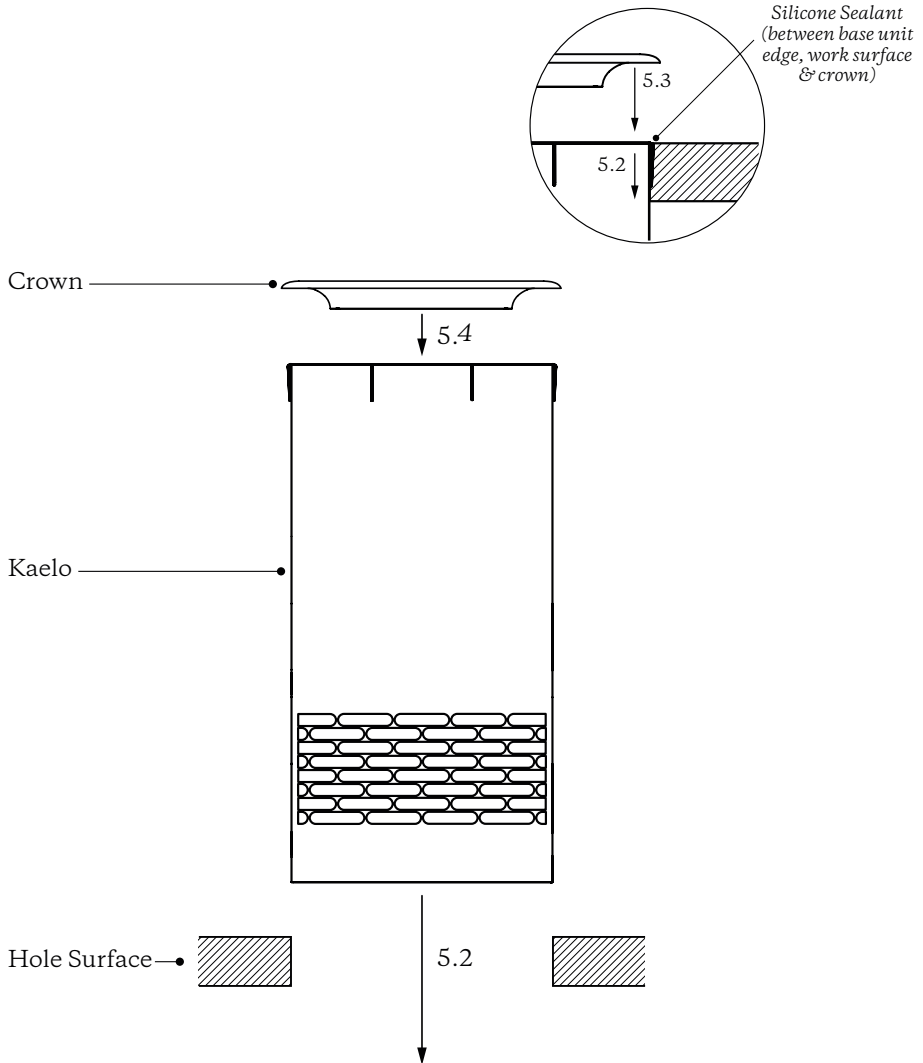

## Important:

Always place the Crown onto the Kaelo unit before plugging into mains power  
If not, the touch controls will not calibrate and it will not function correctly

## 6.1 CUT HOLE & VENT

- For hole cutting - see section 4.2
- For ventilation - see section 5

## 6.2 INSERT KAELO

- Carefully lift the *Kaelo* from the box using two hands and lower slowly into hole. Push down evenly to secure the unit in place
- There is a black circular seal on the base unit top where the Crown will sit, don't remove this

## 6.3 SEAL SURFACE

- Before locating the Crown onto the *Kaelo*, place a bead of silicone at the edge of the *Kaelo* unit lip
- Ensure no silicone is between the Crown and *Kaelo* unit magnets

## 6.4 ATTACH CROWN

- Locate the Crown onto the *Kaelo*, push down evenly to attach the magnets
- Wipe away any excess silicone, taking care not to scratch the Crown surface
- Remove the protective film from the Crown
- **Always ensure the Crown is attached before plugging into mains power**

## 6.5 POWER UP

- The power pack generates a small amount of heat, so place as far away from the *Kaelo* as the installation space and cable allows
- Ensure the power pack is not near a surface that might be subject to liquids. Best practice is to mount onto a surrounding wall
- Plug in power supply to mains and *Kaelo*. Ensure black cable protector is left on. See section 9 (page 21) for testing instructions
- Don't remove the Crown once powered up. If it is removed, turn off the mains power, place the Crown back on. Wait 15 seconds, then turn on at the mains power

# 7. INSTALL: FLUSH

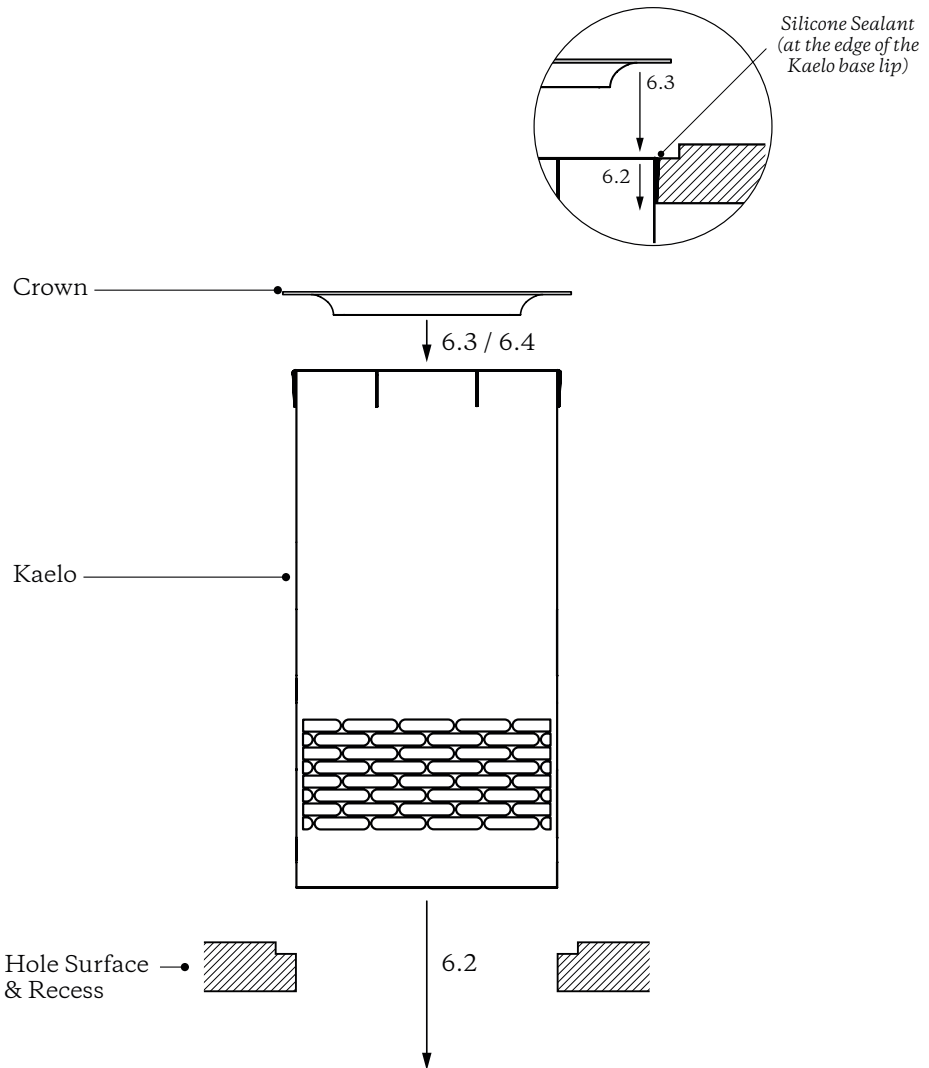

**Important:**

Always place the Crown onto the Kaelo unit before plugging into mains power  
If not, the touch controls will not calibrate and it will not function correctly

## 7.1 CUT HOLE, RECESS & VENT

- For hole and recess cutting - see section 4.3
- For ventilation - see section 5

## 7.2 INSERT KAELO

- Carefully lift the *Kaelo* from the box using two hands and lower into hole. Press down evenly until *Kaelo* unit lip is flush with recess
- There is a black circular seal on the base unit where the Crown will sit, don't remove this

## 7.3 SEAL SURFACE

- Before locating the Crown onto the *Kaelo*, place a bead of silicone at the edge of the *Kaelo* unit lip
- Ensure no silicone is between the Crown and *Kaelo* unit magnets

## 7.4 ATTACH CROWN

- Locate the Crown onto the *Kaelo*, push down evenly to attach the magnets
- Wipe away any excess silicone, taking care not to scratch the Crown surface
- Remove the protective film from the Crown
- **Always ensure the Crown is attached before plugging into mains power**

## 7.5 POWER UP

- The power pack generates a small amount of heat, so place as far away from the *Kaelo* as the installation space and cable allows
- Ensure the power pack is not near a surface that might be subject to liquids. Best practice is to mount onto a surrounding wall
- Plug in power supply to mains and *Kaelo*. Ensure black cable protector is left on. See section 9 (page 21) for testing instructions
- Don't remove the Crown once powered up. If it is removed, turn off the mains power, place the Crown back on. Wait 15 seconds, then turn on at the mains power



# 8. INSTALL: UNDERMOUNT

Align Locking Ring with worktop hole:

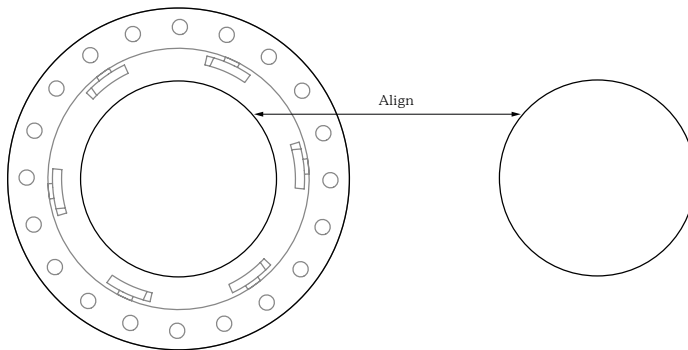

Locking Ring attached  
to Alignment Template

Worktop hole

## PLEASE NOTE

- The Undermount *Kaelo* is attached to the underside of the worktop, unlike the Flush & Curved styles where the Crown sits on top
- For ease of centering the *Kaelo* with the hole, where possible we recommend fixing the Locking Ring to the underside of the worktop during fabrication, before worktop installation

## UNDERMOUNT LID

- With the Undermount, it's possible for a lid to be fabricated and placed in the hole, above the *Kaelo* Crown
- This needs to be specific to the worktop and material being used, and must have a method of removal before placing on the *Kaelo* (please discuss with fabricator or designer)
- We recommend the lid diameter as 121mm
- The lid must have a protective base, such as rubber pads or feet, to prevent scratching the Crown surface

## 8.1 CUT HOLE & VENT

- For hole cutting - see section 4.4
- For vented installations - see section 5

# 8. INSTALL: UNDERMOUNT

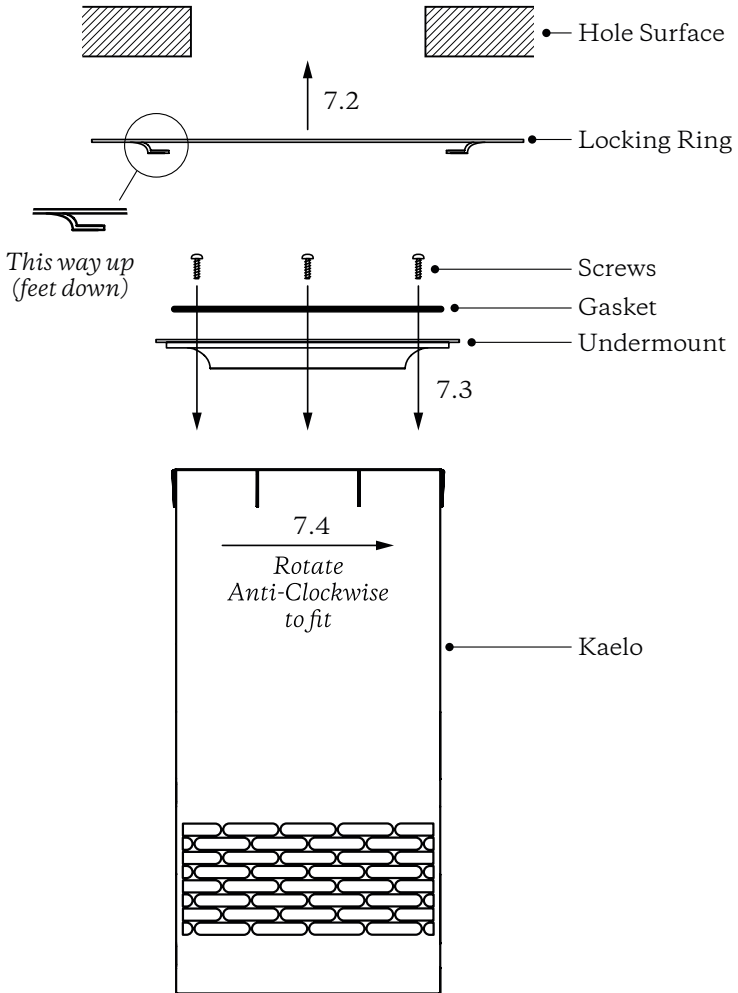

## 8.2 ATTACH LOCKING RING TO WORK SURFACE

- Locking Ring comes with the Alignment Template already attached
- Place epoxy on top side of Locking Ring (or use screws for wooden surfaces)
- Use Alignment Template to centre with worktop hole, see diagram on page 19
- Hold Locking Ring in place using G-clamps, being careful not to damage worktop or Locking Ring feet
- Once epoxy is dry (or screws are in place) remove the Alignment Template and discard

## 8.3 ATTACH CROWN

- Attach Crown and Gasket to *Kaelo* using screws provided
- Lightly lubricate the top side of the gasket with washing up liquid to assist with step 8.4

## 8.4 TWIST KAELO ONTO LOCKING RING

- Carefully lift *Kaelo* towards the Locking Ring and screw **anti-clockwise** until it's securely in place
- Looking down the hole, there should be no gap between the bottom of the worksurface and top of *Kaelo*
- Remove the protective film from the Crown

## 8.5 POWER UP

- The power pack generates a small amount of heat, so place as far away from the *Kaelo* as the installation space and cable allows
- Ensure the power pack is not near a surface that might be subject to liquids. Best practice is to mount onto a surrounding wall
- Plug in power supply to mains and *Kaelo*. Ensure black cable protector is left on. See section 9 (page 21) for testing instructions

# 9. POWER UP & TEST

## 9.1 POWER UP & ENJOY

- Once the *Kaelo* detects power, the lights will flash once. To turn the *Kaelo* on, simply hold your finger on the Crown until the lights turn on
- For full User Guide instructions, head to: [kaelo.co.uk/userguide](http://kaelo.co.uk/userguide) or scan the below QR code to watch our how-to video:



## 9.2 TESTING

- Once *Kaelo* is installed, please perform the following tests to ensure optimal performance:
- Check the *Kaelo* is secure by applying pressure into the chamber
- Hold your finger on the Crown until the lights turn on
- Tap the Crown 3 times, wait until it flashes, then tap repeatedly to check the lights change colour
- Touch the base of the chamber after 3 minutes to check the *Kaelo* is cold
- To turn off, touch and hold the Crown for 2 seconds until the lights turn off

### 9.3 ADDITIONAL TESTING FOR KAELO PLUS ONLY

- Hold your finger on the Crown until the lights turn on
- Hold your finger down on the Crown. Check that the lights change from off, to red, to blue then white

### 9.4 TROUBLESHOOT

- If the *Kaelo* is not operating properly, switch it off at the mains. Ensure the Crown is securely attached to the *Kaelo*, wait 15 seconds, then turn on at the mains.
- Perform steps 9.2 again
- If the *Kaelo* is still not operating properly, in most occasions, the error can be detected by the red flashes. For more information, head to: [kaelo.co.uk/care](http://kaelo.co.uk/care)
- If the problem persists, get in touch: (+44)20 7870 1115
- Quote the unique serial code when getting in touch. This be found at the base of the chamber, underneath the mat, and on the side of the base unit

# 10. SPECIFICATIONS

**CURVED**

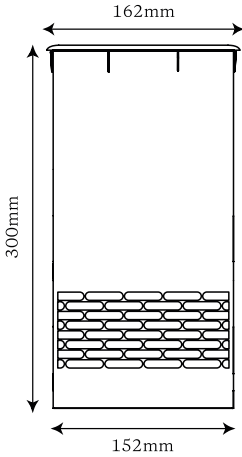

**FLUSH**

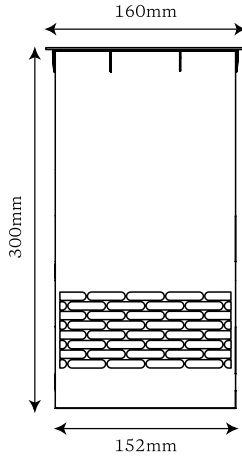

**UNDERMOUNT**

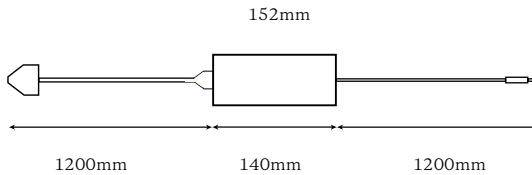
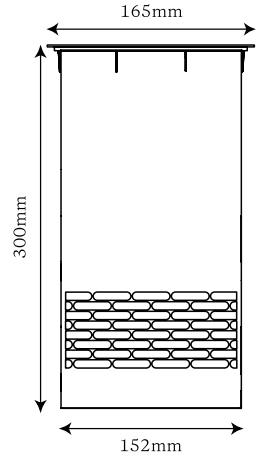

Adapter Input Voltage	100 to 240V AC, 2.5A, 50-60Hz
Kaelo Input Voltage	12 volts
Max Power Usage	85 watts
Max 12v DC Amps	7.5 amps
Auto Switch Off	After 2 hours Tap within the last hour to extend Auto Switch Off by an extra hour
Ambient Temp. Limit	10 to 32°C / 50 to 90°F <i>Kaelo will automatically switch off if the temperature is above 32°C / 90°F</i>

# 11. TRANSPORT & HANDLING

Please only install a *Kaelo* into a fixed surface or unit that will not be moved. If the surface or unit must be moved, please return the *Kaelo* to its original packaging and install once the surface/unit is in its final location and position.

Damages to the appliance, as a result of transporting while installed are not covered under the *Kaelo* warranty.

## 12. SAFETY NOTICE - IMPORTANT

This appliance should not be used by children of any age, or persons with reduced physical, sensory, or mental capacities, unless supervised by an adult at all times.

When *Kaelo* is on and in Boost mode, individuals should refrain from putting their hand deep within the lower part of the chamber, due to hazards from cold surfaces.

For stability, and to avoid hazards, the appliance must be fixed in accordance with the included installation instructions.

We recommend unplugging the *Kaelo* from the mains when not in use.



# KAELO

***Kaelo* installation is usually simple,  
but if you have any questions, we'll always be happy to help:**

info@kaelo.co.uk or call us on (+44) 20 7870 1115

This guide is available online at [kaelo.co.uk/install](http://kaelo.co.uk/install)